

## Acoustic Foldable Partitions



### Movable Partitions Type 65 / 85 /100 Series

Optima manufactures and installs a complete range of Acoustic moveable Wall and sliding folding partition systems, we offer our expertise and service to the industry. Our acoustic foldable partitions can receive different kind of facing such as perforated wood panels, slotted / Grooved wood panels, fabric panels, etc.

We provide solutions to a wide range of environments including golf clubs, schools and colleges, auditoria, training centers, hospitals, offices, restaurants, council chambers, hotels, sports halls and gymnasias, medical centers and race courses.

Type 65 / 85 / 100 Flexible partition include the single piece type and the double piece type enable for all direction and wide turning angle by using these types and suspension wheels.

All frames, acc. Are made of high quality aluminum alloy material.

#### Features & Benefit

- Robust aluminum frame construction for demanding environments.
- Hinged panels for quick and easy operation.
- Wide range of surface finishes.
- Pass door incorporated enabling access to adjoining rooms.
- Stacks one or both ends.
- Top hung and floor with vinyl seals achieving excellent insulation effect.

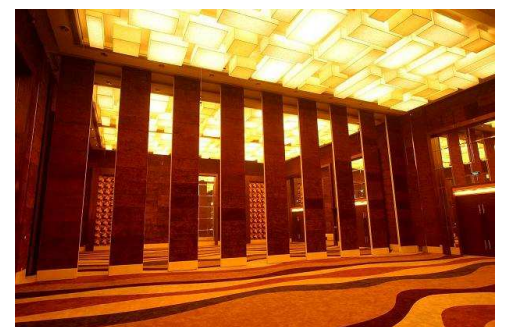

Improving your environment

# Acoustic Foldable Partitions

## Facing Options:

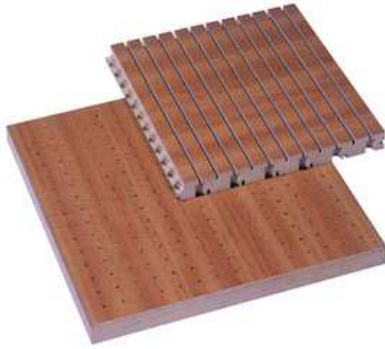

Perforated Panels



Fabric Panels

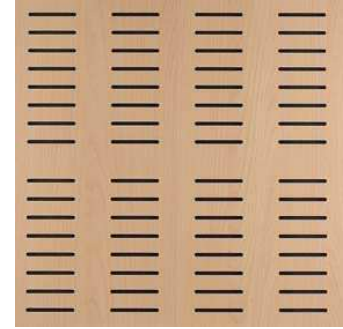

Slotted Panels

Moveable Partition Series & Data Sheet

MODEL	SPECIFICATION (MM)			Acoustic Insulation Coefficient	Hermetic Bar flex Distance	Weight (Kg/sq.m)	Face Board
	Thickness	Width	Max Height				
SP65 – 36D	65mm	800~1210mm	4.5 meters	36 db	45mm	19	Perforated ACOUSTIC PANEL FABRIC WALL PANEL FIRE RESISTANT MDF MELAMINE
SP65 – 36S	65mm	800~1230mm		36 db	45mm	17	
SP65 – 36D	65mm	800~1230mm		36 db	45mm	20	
SP65 – 36S	65mm	800~1230mm		36 db	45mm	20	
SP65 – 45D	65mm	800~1230mm		45 db	45mm	24	
SP85 – 45D	85mm	800~1210mm	4.5~7 meters	45 db	45mm	24	
SP85 – 45S	85mm	800~1230mm		45 db	45mm	25	
SP85 – 45D	85mm	800~1230mm		45 db	45mm	25	
SP85 – 45S	85mm	800~1230mm		45 db	45mm	28	
SP85 – 50D	85mm	800~1230mm		50 db	45mm	38	
SP100 – 55D	100mm	800~1210mm	7~13 meters	55 db	50mm	40	
SP100 – 55S	100mm	800~1230mm		55 db	50mm	40	
SP100 – 55D	100mm	800~1230mm		55 db	50mm	45	
SP100 – 55S	100mm	800~1230mm		55 db	50mm	45	
SP100 – 55C	100mm	800~1230mm		55 db	50mm	48	
<b>SUPER-H</b>	100mm	800~1230mm	13~15 meters	60 db	60mm	60	
SP65G	65mm	800~1100mm	2.5~3.6 meters	28 db	45mm	38	GLASS ACOUSTIC PANEL
SP85G	85mm	800~1100mm	3~5 meters	30 db	45mm	45	

Acoustic Foldable Partitions — AFP

Improving your environment

# Acoustic Foldable Partitions — AFP

## Installation Details

### Steel Structure Installation

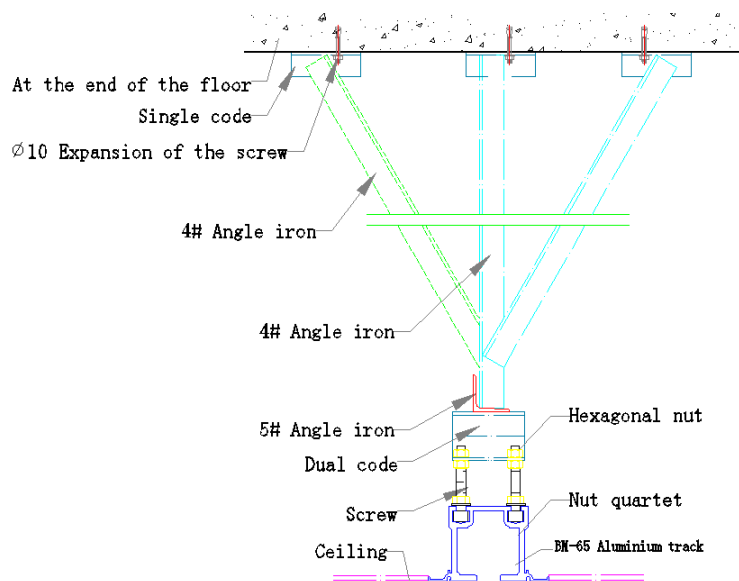
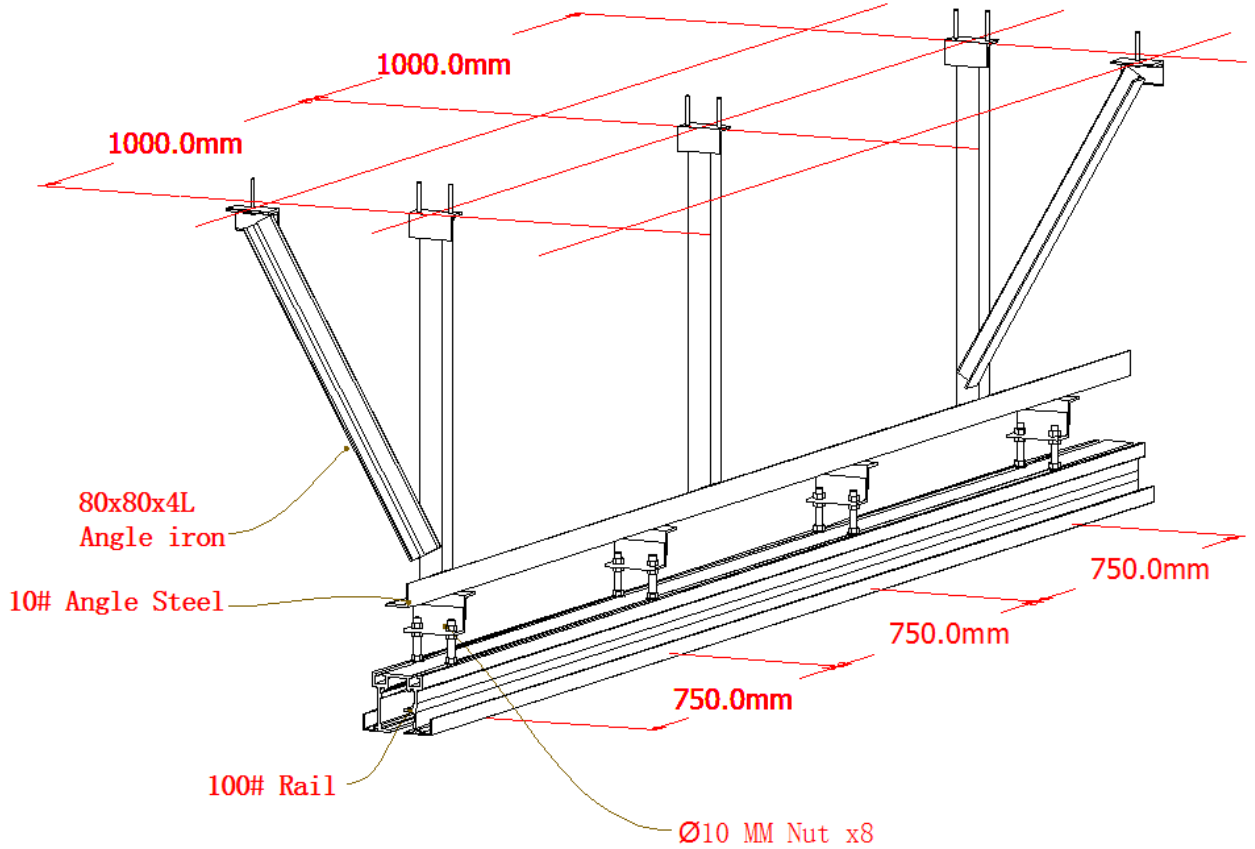

# Acoustic Foldable Partitions

Acoustic Foldable Partitions — AFP

## Installation Details

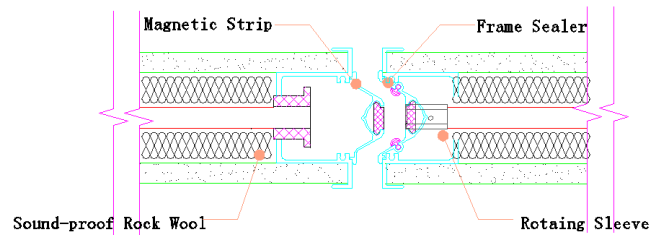
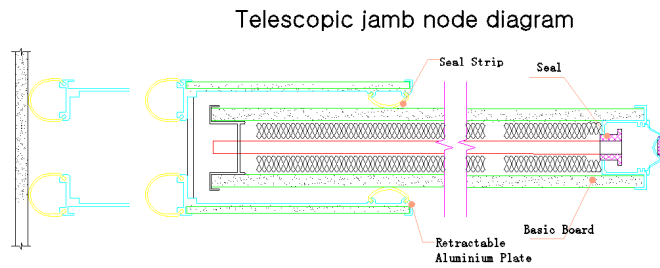
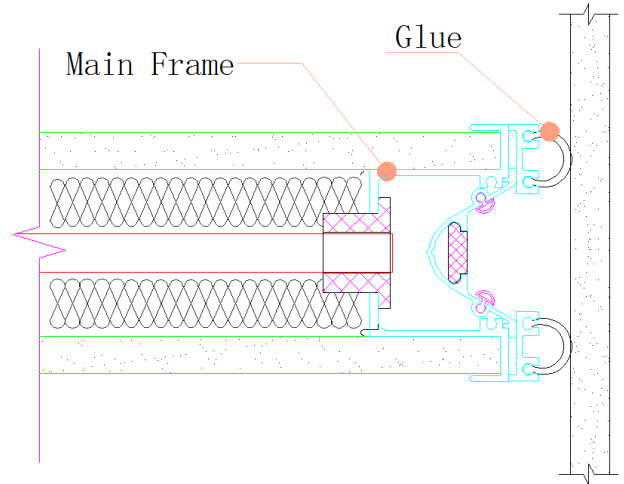
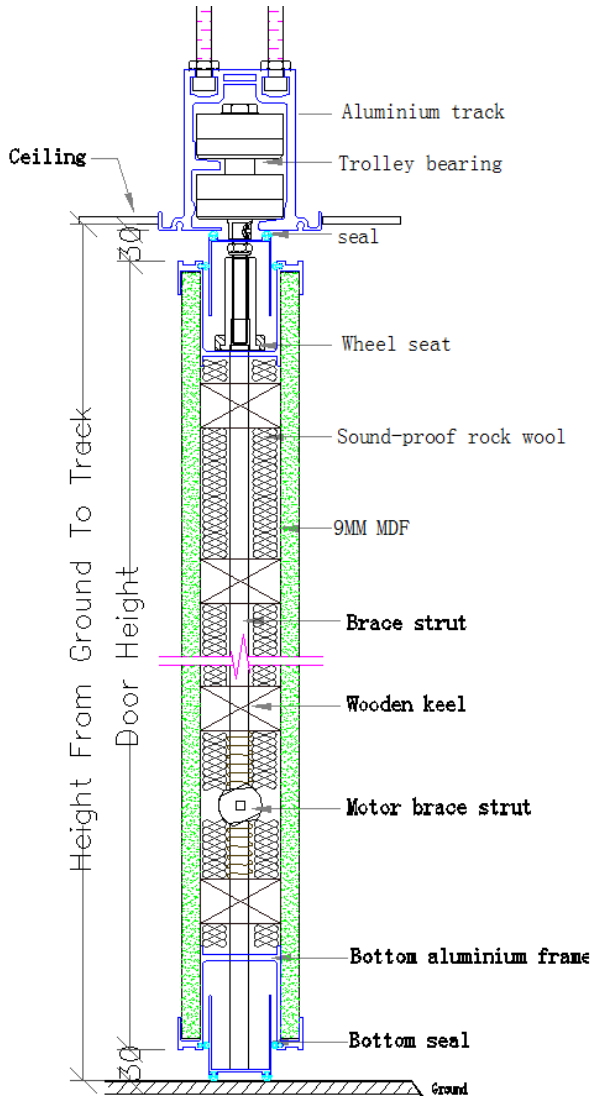

Interlock node diagram

